

PRODUCT SHEET

Description:

End Baluster SS316 Brushed, $\varnothing 42,4 \times 2 \times 1150$ mm, 2 Holes One Side

Item number:

22.10.411-0

Units	Box	Carton	HS Code	Barcode
Pcs.	2	6	8302419000	
				5704866108621

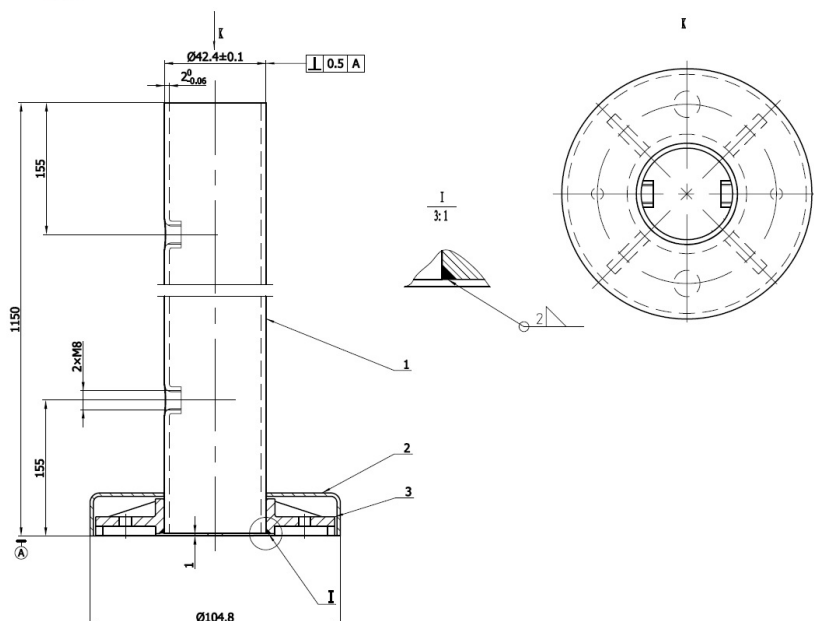

SISO A/S

Mileparken 11
DK-2740 Skovlunde
Denmark
VAT: DK 24786013

Phone +45 45 830 900

www.siso.dk
siso@siso.dk

Danske Bank
Nytorv Branch
Copenhagen
SWIFT: DABADKKK

Account no.
4180 3112 112936
IBAN Account
DK7230003112112936